

**FEATURES**

- \* 0.6 INCH (15 mm) DIGIT HEIGHT.
- \* CONTINUOUS UNIFORM SEGMENTS.
- \* LOW POWER REQUIREMENT.
- \* EXCELLENT CHARACTERS APPEARANCE.
- \* HIGH BRIGHTNESS & HIGH CONTRAST.
- \* DESIGNED FOR CLOCK INDICATION, TIMER FREQUENCY COUNTER, ..., ETC.

**DESCRIPTION**

The LTC-637C1G-12 is a 0.6 inch (15 mm) digit height display. This device utilizes Green LED chips, which are made from GaP on GaP substrate. A green diffusion tape is added on it.

**DEVICE**

<b>PART NO.</b>	<b>DESCRIPTION</b>
Green	Common Cathode
LTC-637C1G-12	

## PACKAGE DIMENSIONS

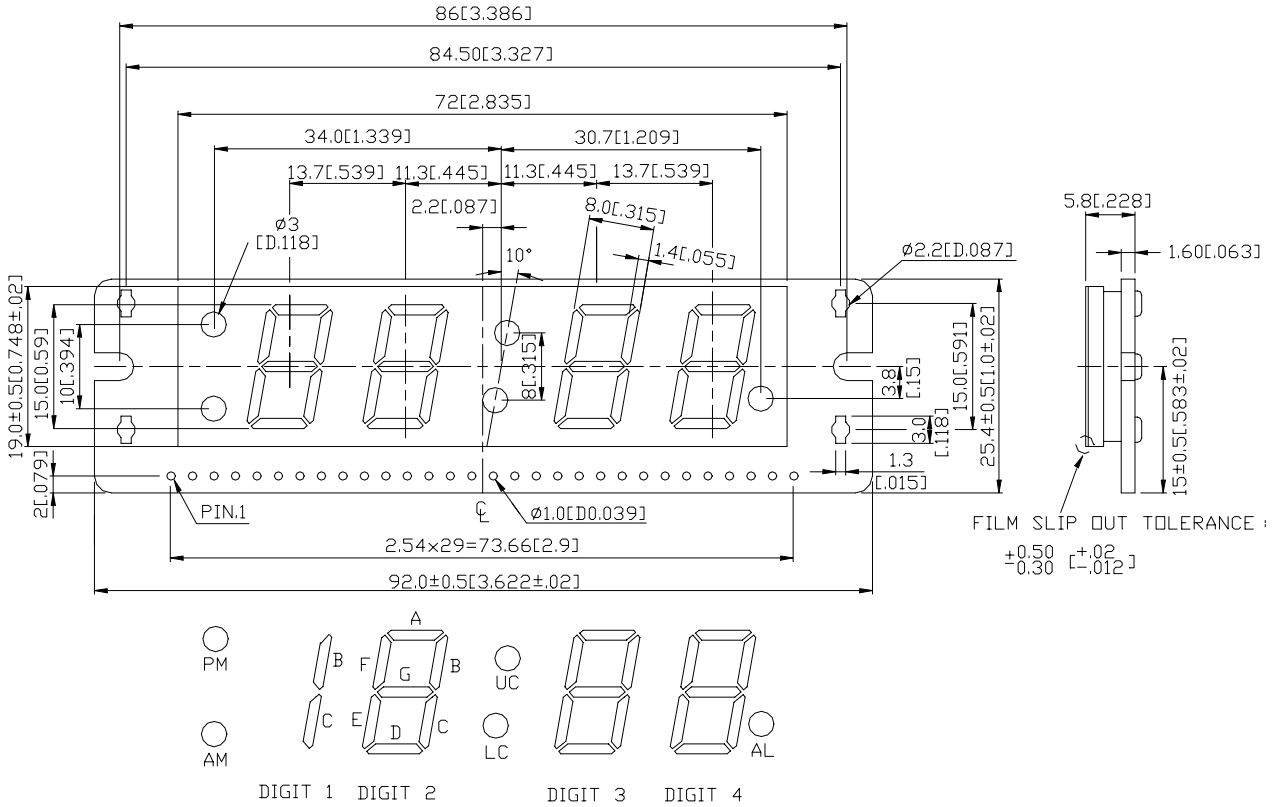

NOTES: All dimensions are in millimeters. Tolerances are  $\pm 0.25$ -mm (0.01") unless otherwise noted.

## INTERNAL CIRCUIT DIAGRAM

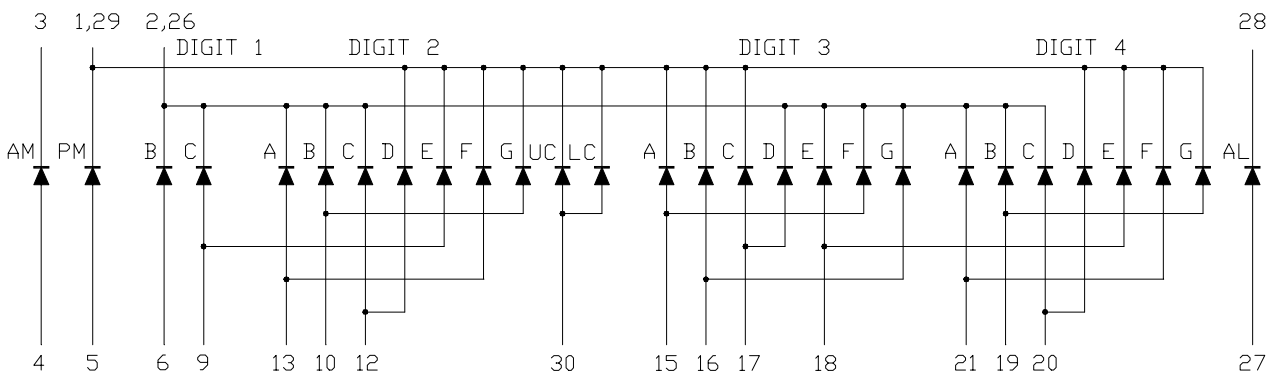

**PIN CONNECTION**

NO.	CONNECTION	NO.	CONNECTION
1	Common Cathode 1	16	Digit 3 Anode B, Digit 3 Anode G
2	Common Cathode 2	17	Digit 3 Anode C, Digit 3 Anode D
3	Cathode AM	18	Digit 3 Anode E, Digit 4 Anode E
4	Anode AM	19	Digit 4 Anode B, Digit 4 Anode G
5	Anode PM	20	Digit 4 Anode C, Digit 4 Anode D
6	Digit 1 Anode B	21	Digit 4 Anode A, Digit 4 Anode F
7	No Connection	22	No Connection
8	No Connection	23	No Connection
9	Digit 2 Anode E, Digit 1 Anode C	24	No Connection
10	Digit 2 Anode B, Digit 2 Anode G	25	No Connection
11	No Connection	26	Common Cathode 2
12	Digit 2 Anode C, Digit 2 Anode D	27	Anode AL
13	Digit 2 Anode A, Digit 2 Anode F	28	Cathode AL
14	No Connection	29	Common Cathode 1
15	Digit 3 Anode A, Digit 3 Anode F	30	Anode UC, Anode LC

**ABSOLUTE MAXIMUM RATING AT Ta=25°C**

PARAMETER	MAXIMUM RATING	UNIT
Power Dissipation Per Segment	75	mW
Peak Forward Current Per Segment ( 1/10 Duty Cycle, 0.1ms Pulse Width )	100	mA
Continuous Forward Current Per Segment	25	mA
Forward Voltage, Per Segment	0.33	mA/°C
Reverse Voltage Per Segment	5	V
Operating Temperature Range	-25°C to +65°C	
Storage Temperature Range	-25°C to +65°C	
Solder Temperature: 3.5mm Below PCB.back side for 3sec. at 260°C		

**ELECTRICAL / OPTICAL CHARACTERISTICS AT Ta=25°C**

PARAMETER	SYMBOL	MIN.	TYP.	MAX.	UNIT	TEST CONDITION
Average Luminous Intensity	I <sub>v</sub>	200	600		μcd	I <sub>F</sub> =10mA
Peak Emission Wavelength	λ <sub>p</sub>		565		nm	I <sub>F</sub> =20mA
Spectral Line Half-Width	Δλ		30		nm	I <sub>F</sub> =20mA
Dominant Wavelength	λ <sub>d</sub>		569		nm	I <sub>F</sub> =20mA
Forward Voltage Per Segment	V <sub>F</sub>		2.1	2.6	V	I <sub>F</sub> =20mA
Reverse Current Per Segment	I <sub>R</sub>			100	μA	V <sub>R</sub> =5V
Luminous Intensity Matching Ratio	I <sub>v</sub> -m			2:1		I <sub>F</sub> =10mA

Note: Luminous intensity is measured with a light sensor and filter combination that approximates the CIE (Commision Internationale De L'Eclariage) eye-response curve.

## TYPICAL ELECTRICAL / OPTICAL CHARACTERISTIC CURVES

(25°C Ambient Temperature Unless Otherwise Noted)

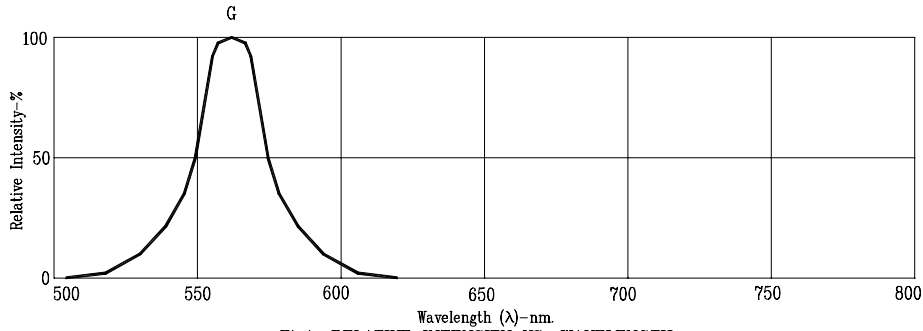

Fig1. RELATIVE INTENSITY VS. WAVELENGTH

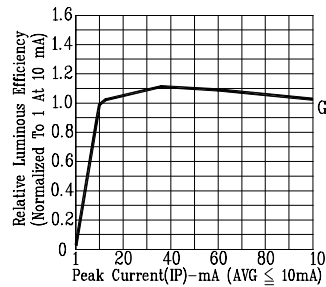

Fig2. RELATIVE LUMINOUS EFFICIENCY (LUMINOUS INTENSITY PER UNIT CURRENT) VS. PEAK CURRENT (REFRESH RATE 1KHz)

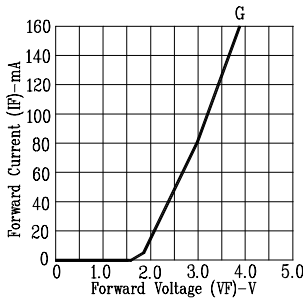

Fig3. FORWARD CURRENT VS. FORWARD VOLTAGE

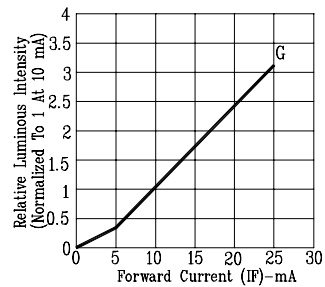

Fig4. RELATIVE LUMINOUS INTENSITY VS. FORWARD CURRENT

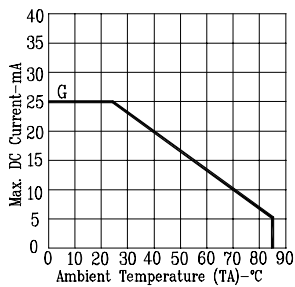

Fig5. MAX. ALLOWABLE DC CURRENT VS. AMBIENT TEMPERATURE.

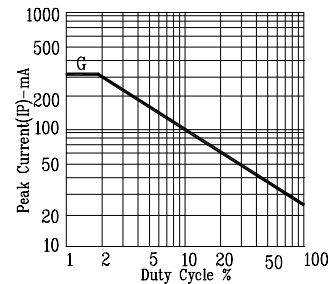

Fig6. MAX. PEAK CURRENT VS. DUTY CYCLE % (REFRESH RATE 1KHz)

NOTE: G=GREEN